

COMPACT BRAZED HEAT EXCHANGER

B35

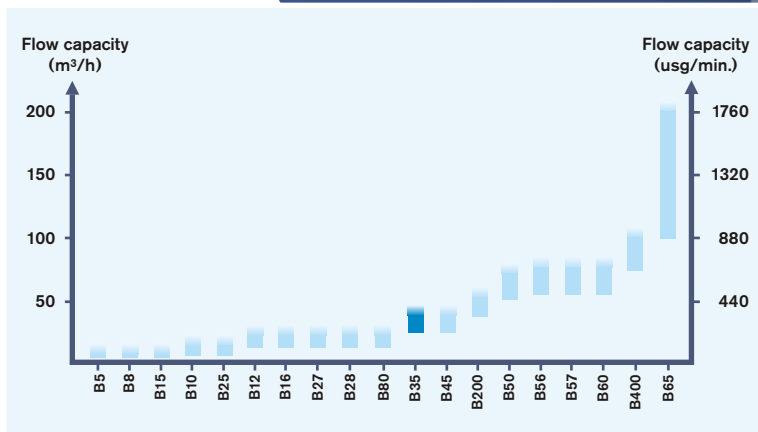
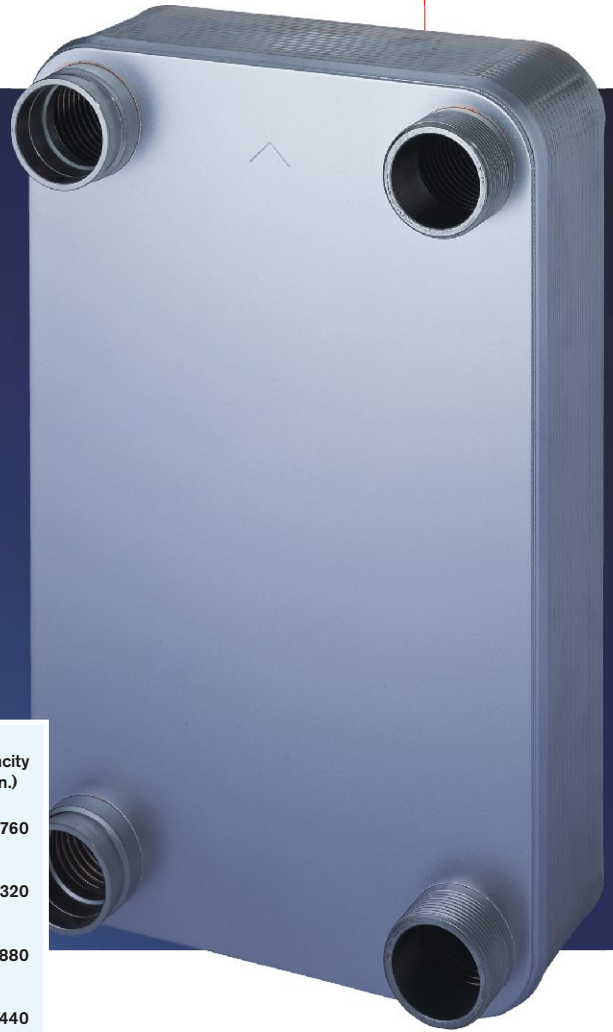

The B35 is more flexible, and is available immediately with numerous standard connections. The product's size and capacity interval mean it operates efficiently in many single- and two-phase applications. Despite its small size, the product accepts as many as 250 plates.

B35

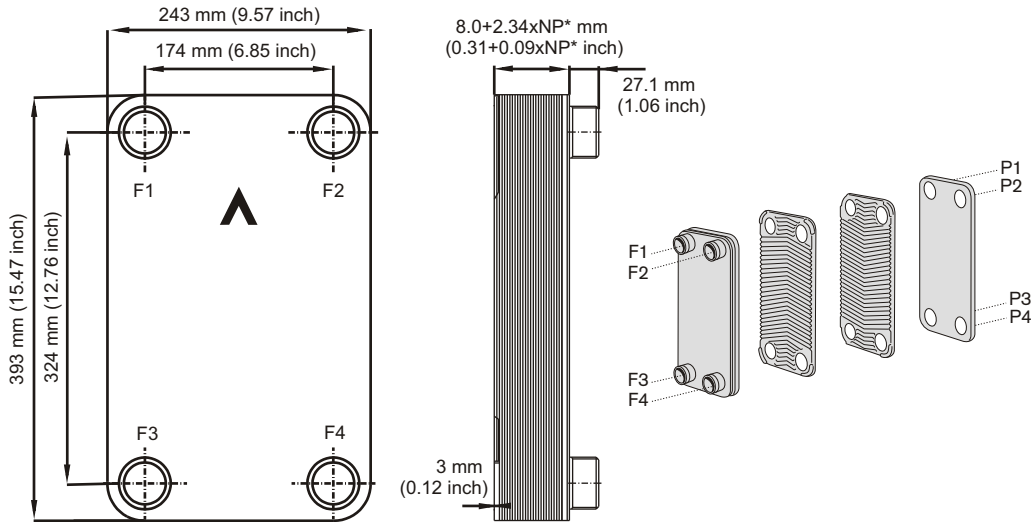

STANDARD CONNECTIONS

For specific dimensions, or information about other types of connections, please contact your SWEP sales representative.

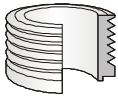

Externally threaded

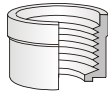

Internally threaded

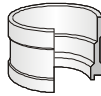

Soldering

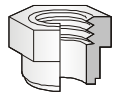

Int. Threaded with Hex. Ext.

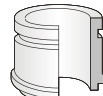

Victaulic



DNC Flanges

TECHNICAL DATA

Max flow rate	35 m ³ /h (154 usg/min.)
Max working pressure at 155°C (311°F)	31 bar (450 psi)
Max working pressure at 225°C (437°F)	27 bar (392 psi)
Min working temperature	-196°C (-321°F)
Test pressure	50 bar (725 psi)
Max. Number of plates	250
CBE weight dry (approx.)	6.7+0.336×NP* kg (14.77+0.741×NP* lb)
Hold-up volume: inner circuit	0.175×(NP*/2-1) litre (0.046×(NP*/2-1) gal.)
Hold-up volume: outer circuit	0.175×NP*/2 litre (0.046×(NP*/2) gal.)
Standard connection size	1 1/2"
Connection height	27.1 mm (1.06 inch) or 54.2 mm (2.13 inch)

*NP = Number of plates

MATERIAL

Plate material:	EN 10028/7-1.4401 (AISI 316)
Brazing material:	Pure copper
Connection material:	EN10272 - 1.4401 (AISI316) or EN10222 - 1.0305 (A106)

THIRD-PARTY APPROVALS (selection)

Europe, Pressure Equipment Directive (PED 97/23/EC)
 USA, Underwriters Laboratories (UL)
 USA, American Society of Mechanical Engineers (ASME)
 Canada, Canadian Standard Association (CSA)
 Japan, The High Pressure Gas Safety Institute of Japan (KHK)

For additional information please contact your local SWEP representative.
 SWEP reserves the right to make changes without prior notice

THE B LINE – OUR BASIC RANGE

The majority of SWEP's CBEs are classified as B-types. The B-types are suitable for most applications. Although the B-type CBEs are "standard", there is a huge variety of plate sizes, port sizes, plate pattern combinations, connections etc. And SWEP's unique plate design enables a virtually unlimited number of combinations in any given plate package execution to precisely match the thermal transfer requirements of your application.



Easy to choose the right product solution

With SWEP's unique SSP CBE, the SWEP Software Package, you can do advanced heat transfer calculations yourself, and choose the product solution that suits your application best. It's also easy to choose connections and generate drawings of the complete product. If you would like advice, or you would like to discuss different product solutions, SWEP offers all the service and support you need.

If you would like more information about B35 or our other products, please contact your local SWEP representative.